

| Design Data | |
|-----------------------|----------------|
| Commutation | Brushed |
| Direction of rotation | Bi-directional |
| Bearing type | |

| Performance data | | |
|-------------------------------------|-------|------|
| Rated voltage [V] | U_N | 12 |
| Nominal torque [Nm] | M_N | 0.24 |
| No-load speed [min^{-1}] | n_0 | 17.0 |
| Nominal power [W] | P_N | 0.37 |
| Nominal current [A] | I_N | 0.0 |
| Nominal force [kN] | F_N | 0.00 |
| Duty cycle | | s3 |

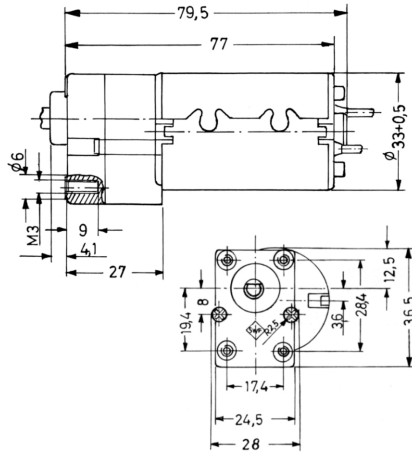

| Sensor data | |
|-----------------|---|
| Pulses | 0 |
| Output channels | 0 |

| Other data | |
|------------------------|-------|
| Gear ratio | 109/1 |
| Gear wheel material | |
| Suppression components | |
| Enclosure class | IP40 |
| Weight [kg] | 0.180 |

Remarks:

Motor picture

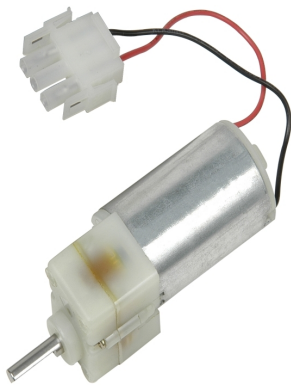

Characteristic curves

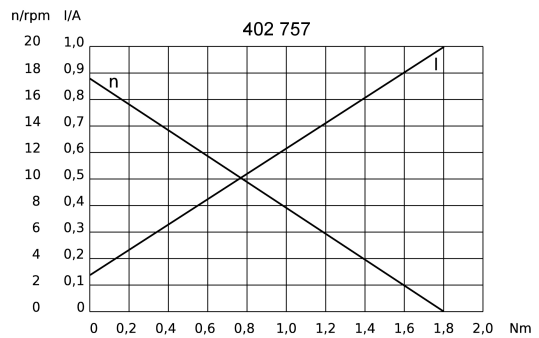

Output shaft drawing (W), Wiring diagrams (S) and Connector layout (K)

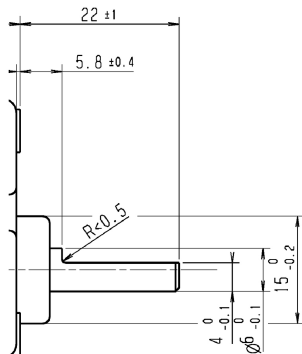

S 30

