

Series DCK31

Motor type 404 865

Design Data	
Commutation	Brushed
Direction of rotation	Bi-directional
Bearing type	A: Ball - B: Sleeve

Performance data		
Rated voltage [V]	U_N	24
Nominal torque [Nm]	M_N	4.00
No-load speed [min^{-1}]	n_0	75.0
Nominal power [W]	P_N	28.9
Nominal current [A]	I_N	5.5
Nominal force [kN]	F_N	0.00
Duty cycle	s1	

Sensor data	
Pulses	69
Output channels	2

Other data	
Gear ratio	69/1
Gear wheel material	Plastic
Suppression components	6.0 μ H, 1nF
Enclosure class	IP30
Weight [kg]	1.210

Remarks: d = for thread-forming screw M6 DIN ISO 965-2

Characteristic curves

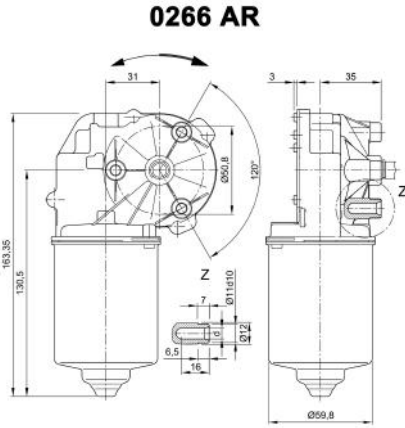

Motor picture

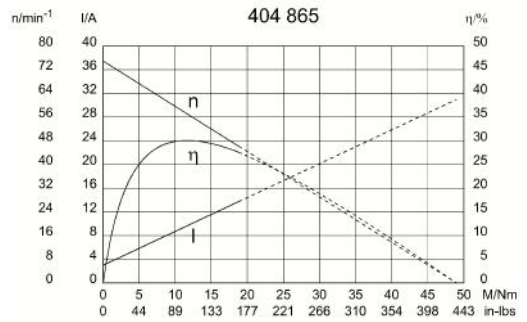

Output shaft drawing (W), Wiring diagrams (S) and Connector layout (K)

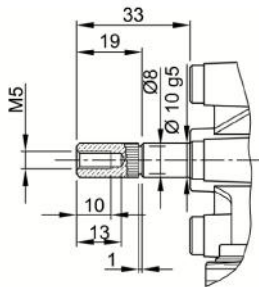

S 30

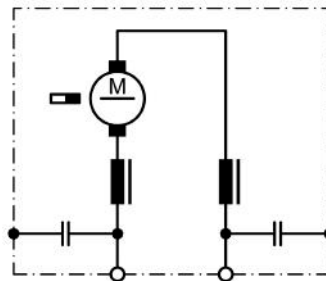

S 141

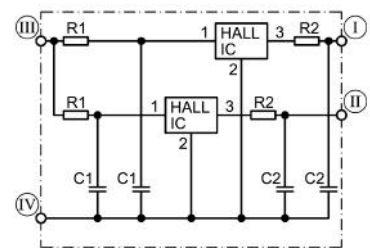

- I Hall-IC A1, terminal 3
- II Hall-IC A2, terminal 4
- III Hall-IC +, terminal 5
- IV Hall-IC -, terminal 6

Output shaft drawing (W), Wiring diagrams (S) and Connector layout (K)

K 320

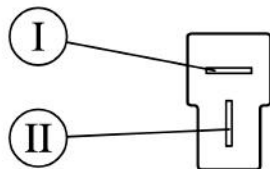

Fiat plug (DIN 46244) 6,3x0,8 mating with receptacle housing part#180907, drwg# C-180907& Receptacles for tabs, conductor cross section 0,5-1,5 sqmm (20-18AWG) part# 925603-x, drwg# 925603 www.tycoelectronics.com

K 321

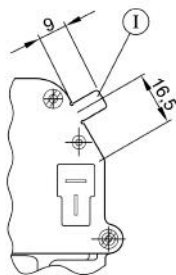

I Ground connection
Blade terminal 6.3 x 0.8 DIN 46 244

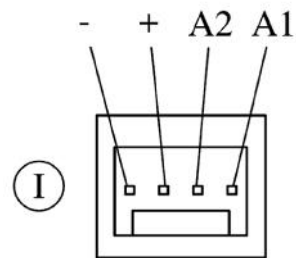

I Mating connector: Panduit CE100 F22-04

Notes
